

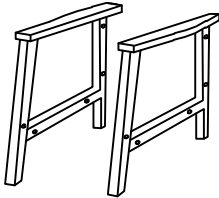







部品内容一覧	G 肘	H 長座クッション
 A ボルト X10	 左右各×1	 長座クッション X1
 B ワッシャー X10		
 C 六角レンチ X1	I 座クッション  座クッション X2	J 背クッション  背クッション X1
 D 木製脚 X4		
 E 真中脚 X1	K 座クッション本体  座クッション本体 X1	L 座クッション本体  座クッション本体 X1
 F フェルト X9		

2/8

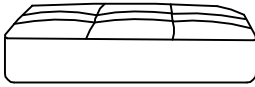
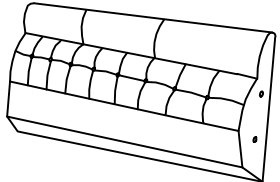

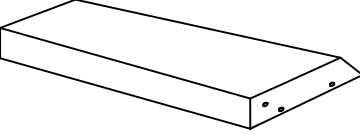
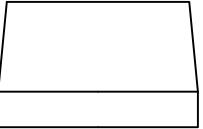
※注意※

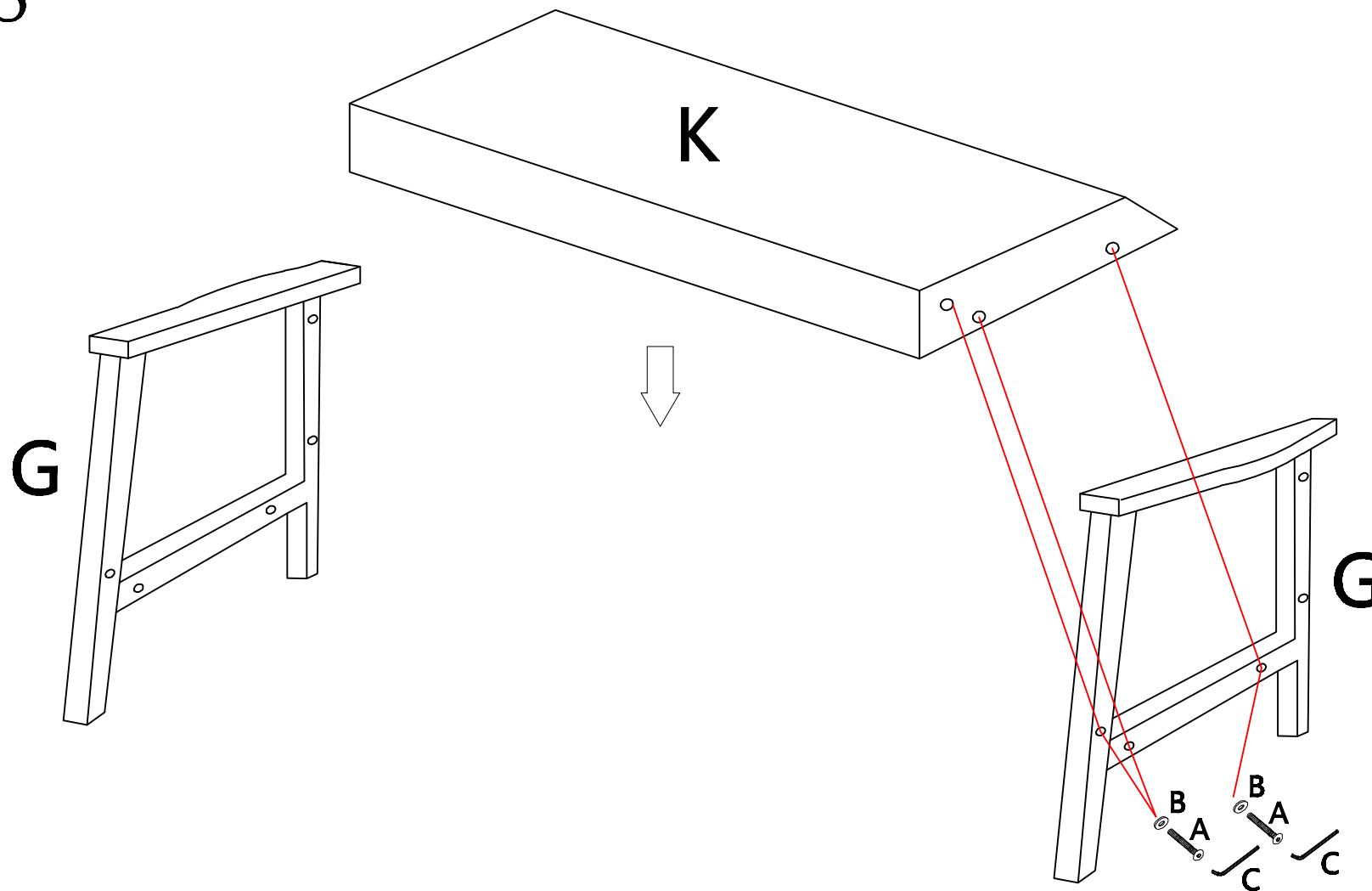
ここではボルトは仮締めです。

3/8で【J: 背クッション】にもボルトを付けた時に
本締めをして下さい。

3/8

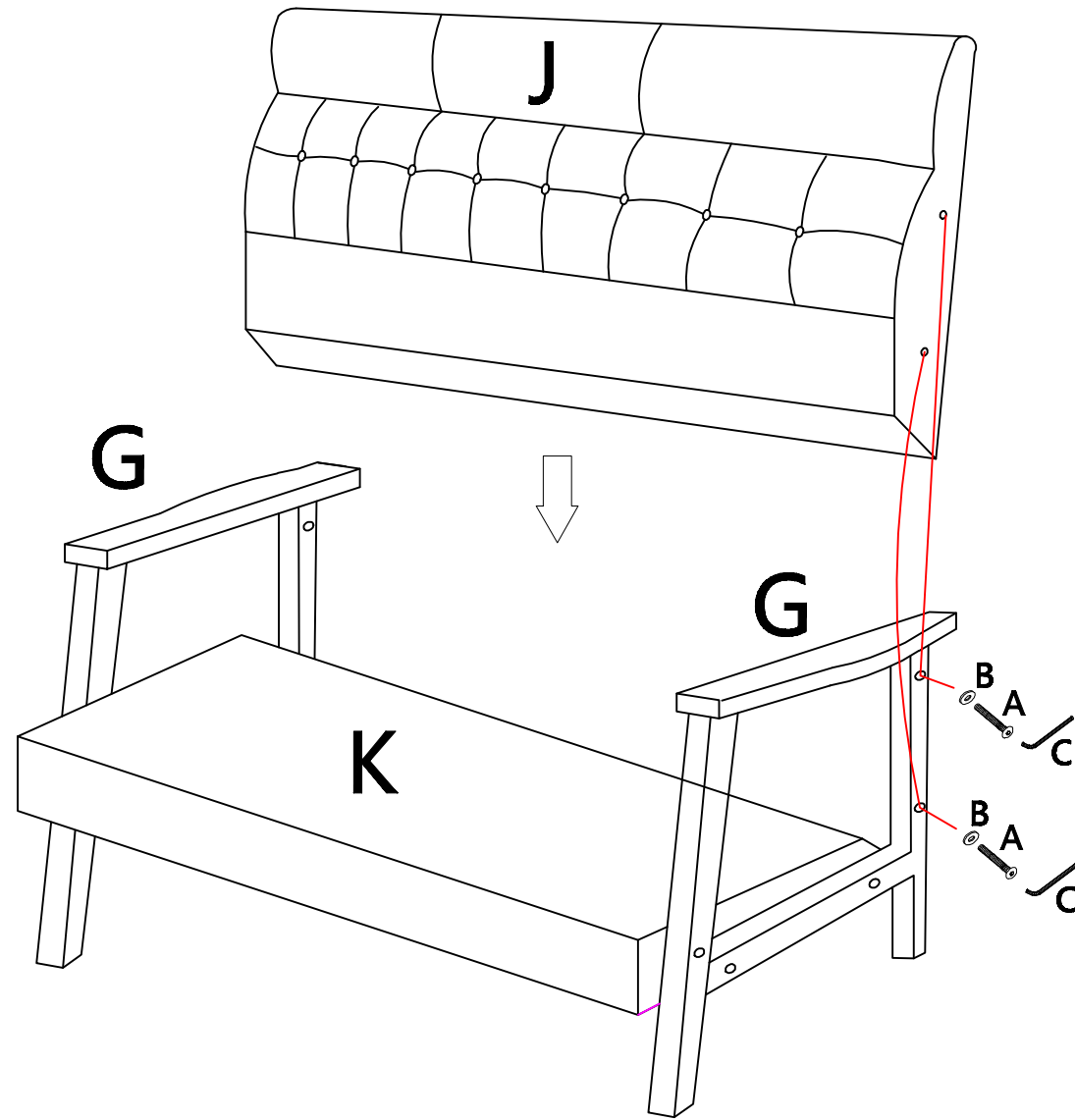

4/8

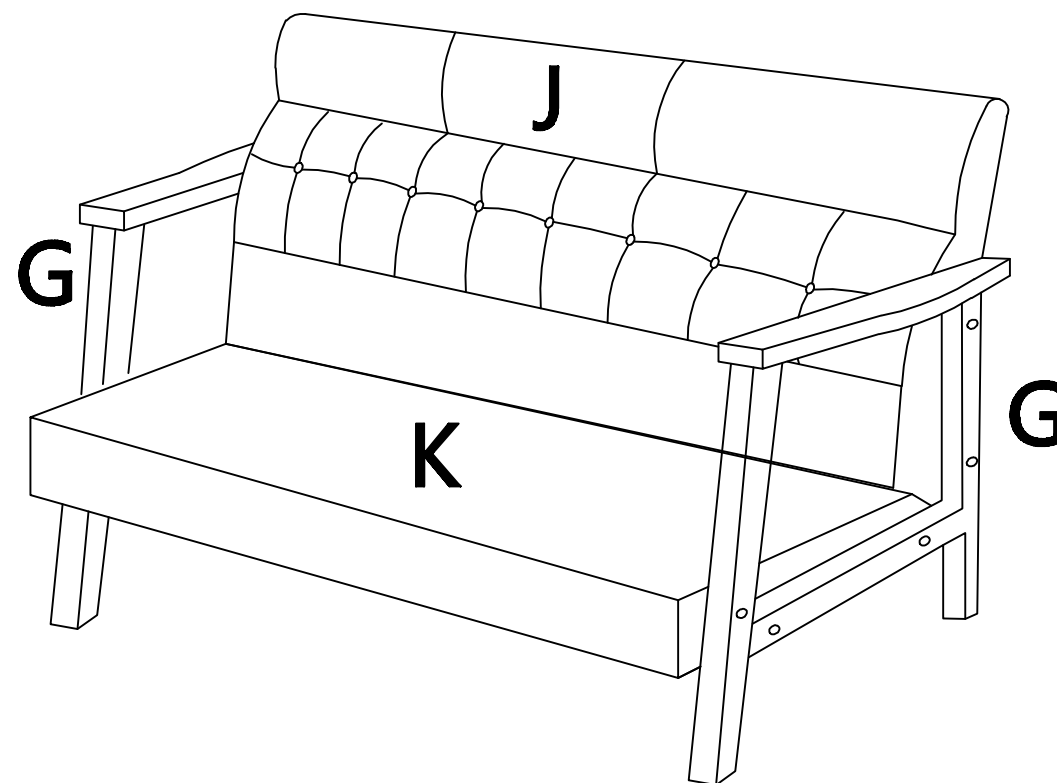

5/8

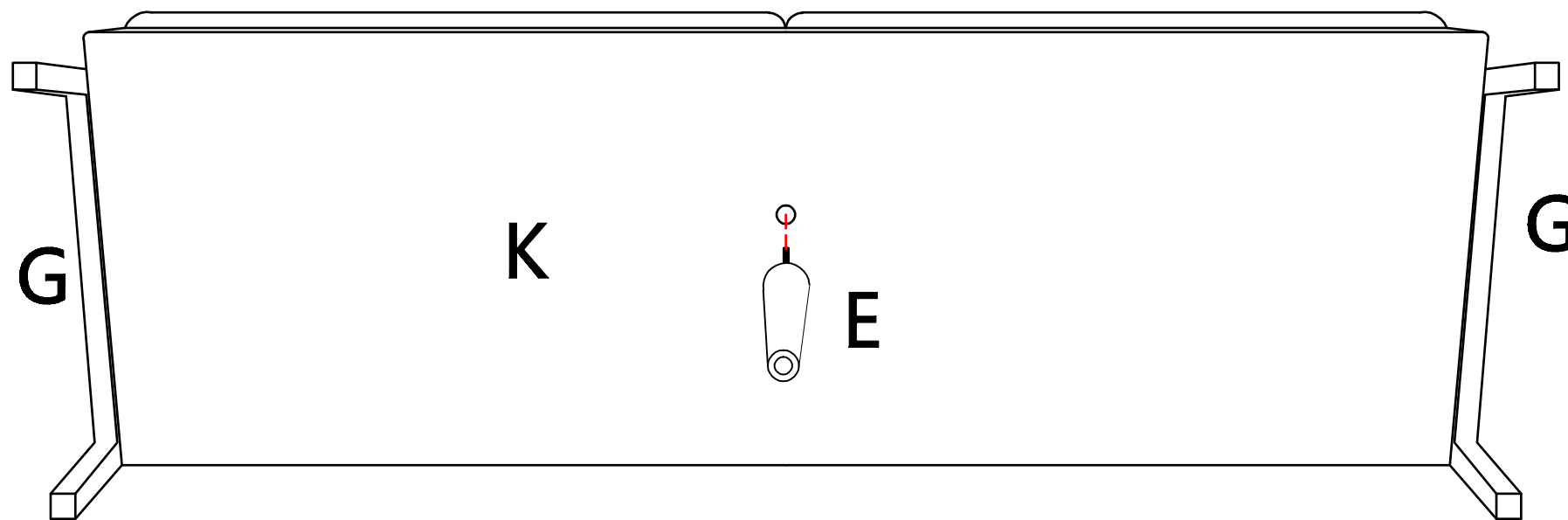

6/8

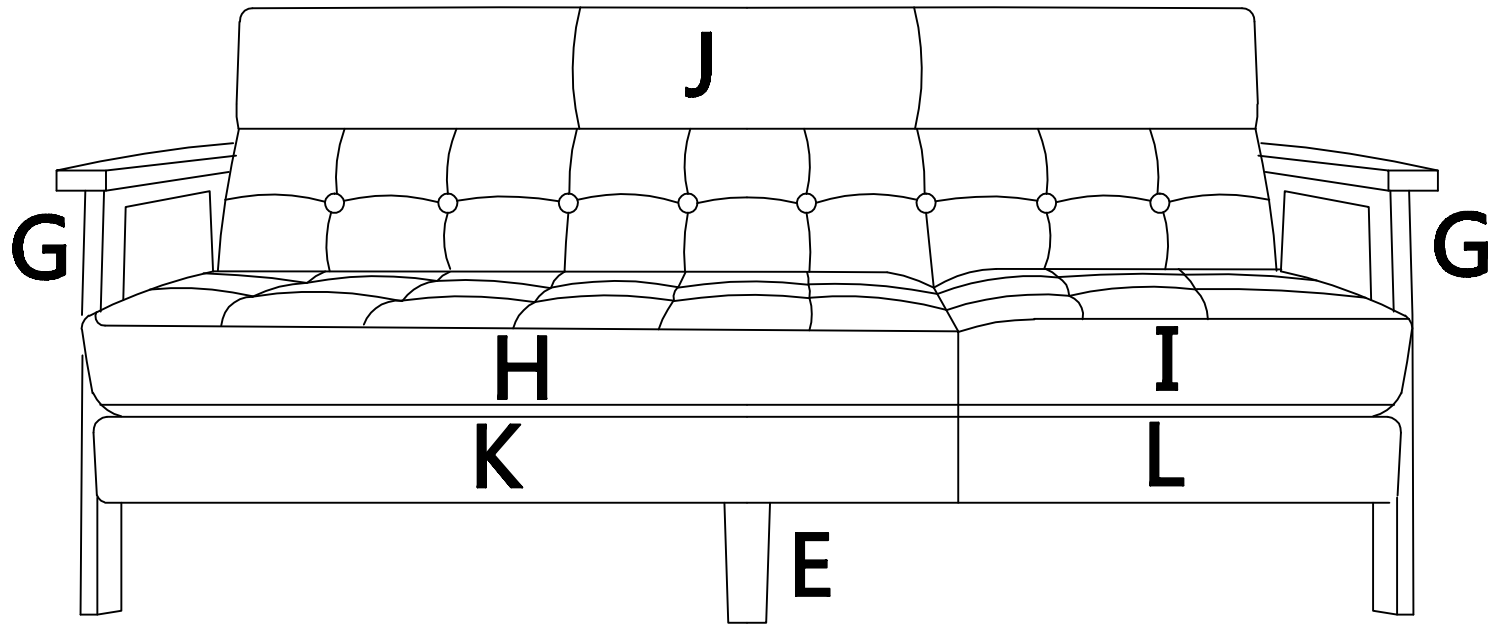

7/8

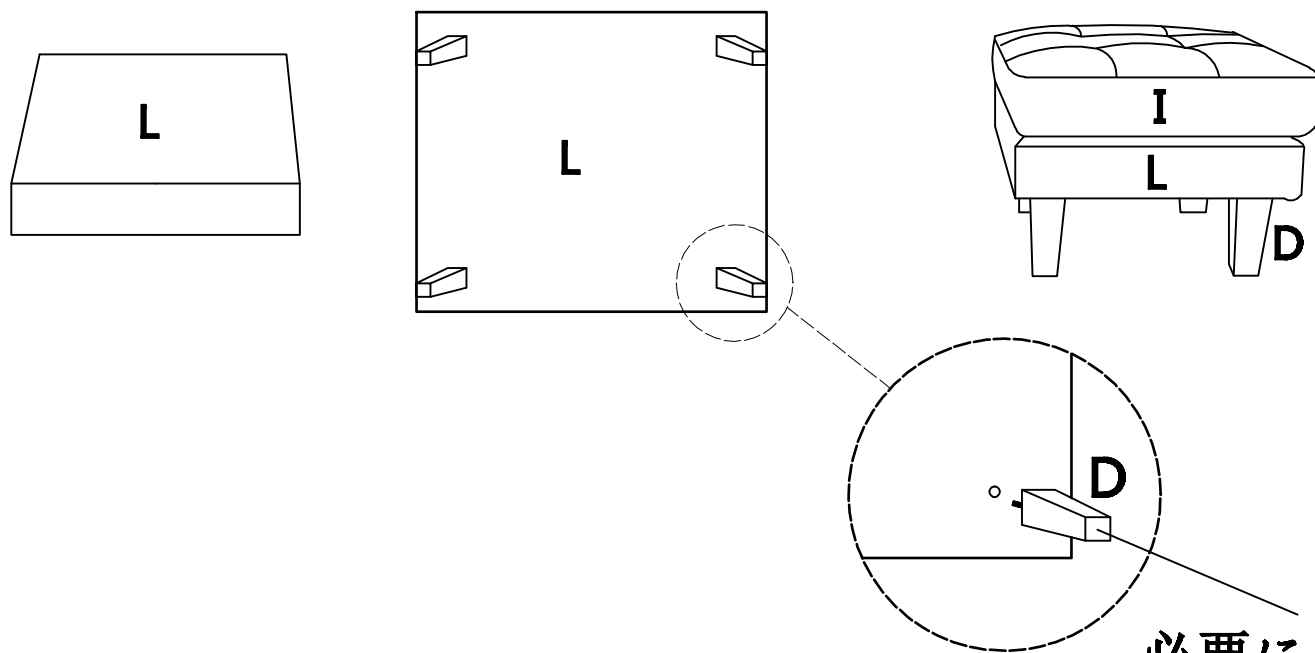

必要に応じてフェルトFを
脚裏に貼ってください。

8/8

